

Folding sliding aluminum doors Technical information

S55

Vertical section

Dimensions in inch

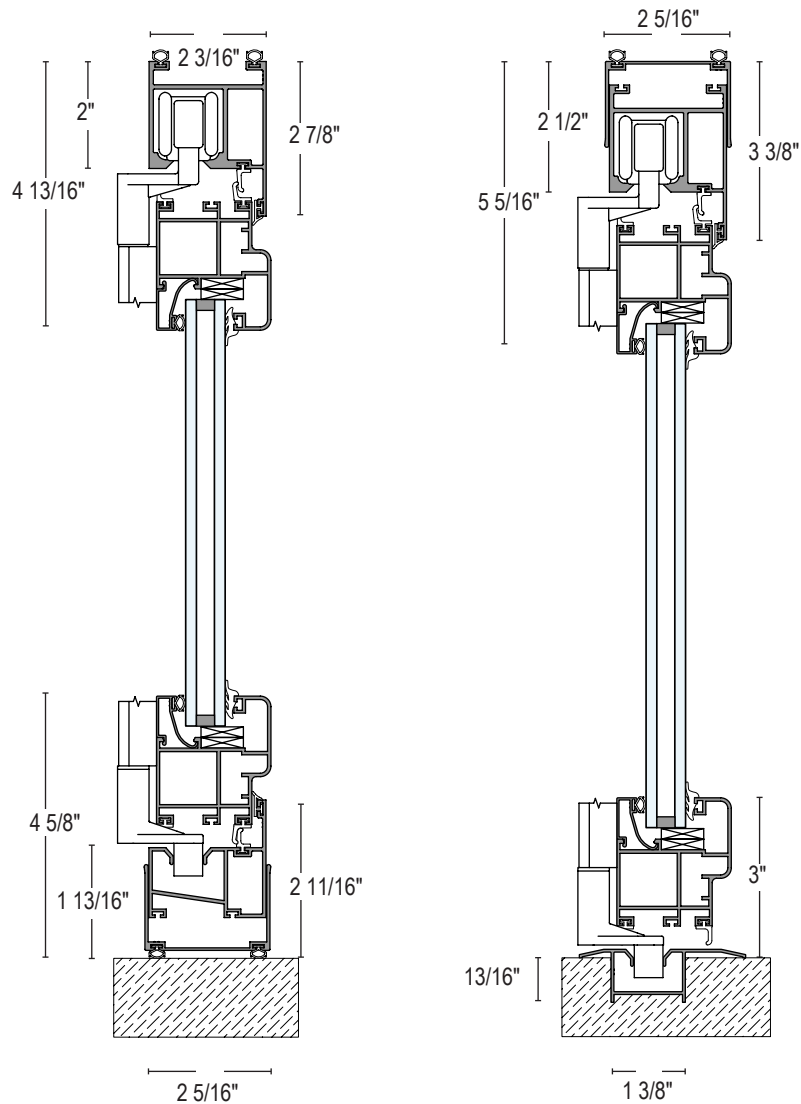

Raised bottom track

Recessed bottom track

*Dimensions are valid, except for misprints

Features

- Special reinforced series with rounded edges and triple weather-tight gasket. Allows for the creation of slightly curved systems or systems which occupy a wide radius.
- Available with: 1/2"(13mm), 3/4"(19mm), 15/16"(23mm) and 1 1/16"(27mm) gaps for the incorporation of glazing or panels.
- Leaves can open inwards or outwards, and can incorporate one or more mid rails.
- Fitted with horizontal and vertical glazing beads.
- Series with optional flush-mounted or surface-mounted bottom track.
- Includes U-shaped compensation profile to correct minor misalignments.
- Optional incorporation of standard handles, business-type handles or three-point bolt locks.
- Accessories are available in white, black and on demand, in the same colors as the profiles.
- Series in epoxy polyester powder coated in any of 210 shades included in the classic RAL color range, anodized or decorated with a wood-grain effect.

Horizontal section

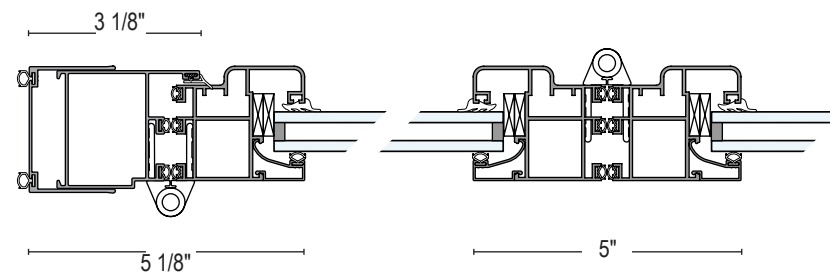

Folding sliding doors. Technical information.

Openings

Opening types

Both sides inward opening.
Number of leaves: odd and odd.

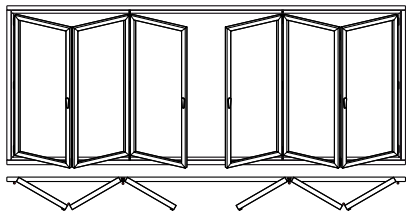

Left inward opening.
Number of leaves: odd.

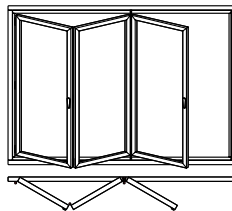

Both sides inward opening.
Number of leaves: odd and pair.

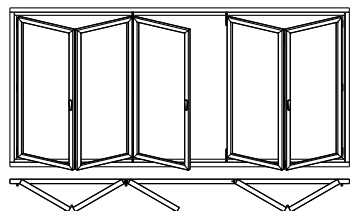

Interior opening both sides.
Number of leaves: pair and pair.

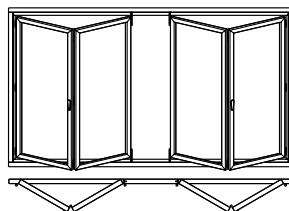

Left outward opening.
Number of leaves: odd.

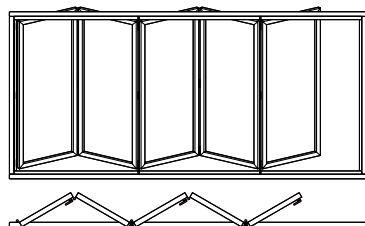

Indistinct inward opening.
Number of leaves: pair.

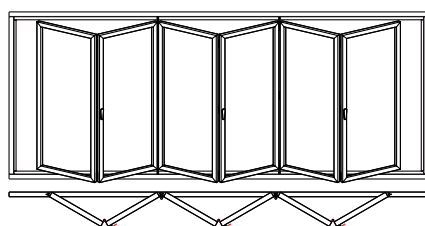

Right inward opening.
Number of leaves: pair.

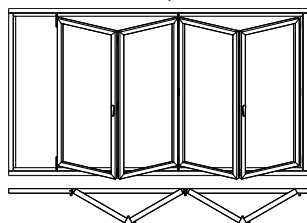

Indistinct inward opening with hinged doors.
Number of leaves: pair.

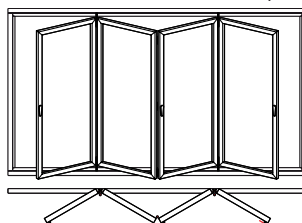

There are many possibilities to adjust the opening configuration to suit your requirements. You can slide the doors as you wish. You can slide all the panels to right or left side, or both sides. You also have the possibility to open them either to right and left side. Panels can be folded inwards or outwards.

Features



Folding sliding aluminum doors Technical information

CoverSpace, LLC
100 West Road, Suite 300, Towson, MD 21204
info@coverspace.us
<https://coverspace.us>

